

## Fitting Instructions Pacer 130kg Clamp - Husky 75kg Clamp.

### Tools required

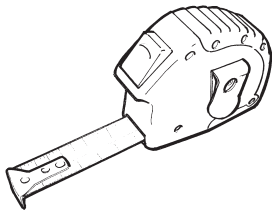

1 x Tape measure

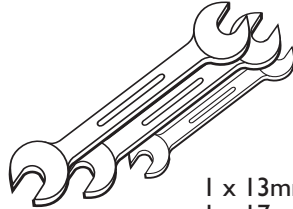

1 x 13mm Spanner  
1 x 17mm Spanner  
1 x 24mm Spanner

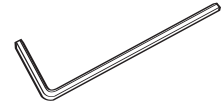

1 x Allen Key - 5mm

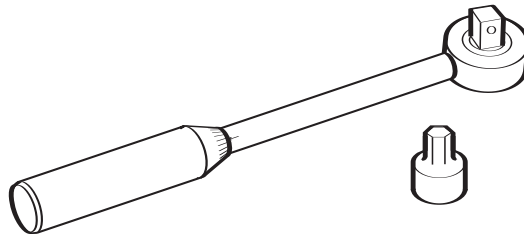

1 x Torque wrench and 6mm hex drive

1. Install the track with the hangers and clipstops in the track.
2. Clean clamping areas of the glass panel to remove all dirt, dust and grease.
3. Attach the loosely assembled glass clamps to the glass panel, 70mm in from each end. For ease of installation have the apron plate slot facing towards the track and away from the installer. Ensure that there is 5mm clearance between the top of the glass panel and the bottom clamp profile. When the glass is fully located within the clamp and in the correct position tighten the M8x40 bolts to 25Nm with torque wrench.
6. Position the hangers in the track the same distance apart as the glass clamps. Align the bolt flats of the hanger strap bolts with the glass clamp apron slots, then lift the glass panel onto the hanger strap bolts.
7. Adjust the glass panel height to the correct position by rotating the hanger strap bolts, adjust the anti-rise bolt.
8. Align the bolt flats to the line of the glass, then tighten the M16 lock nut.
9. Position the clip stops in the track so that they bring the hangers to a stop when the panel is in the desired position and prevents the glass panel sliding out of the floor guide.

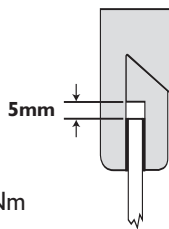

4. Where two nylon bottom glass guides are provided (8/10mm kits) select the correct guide for the glass thickness.

8mm glass guide



10mm glass guide



12mm glass guide



5. Locate and secure the bottom guide to the floor using the wood screws provided.

### Parts list

- 2 x Glass clamps
- 2 x Hangers (Pacer or Husky)
- 2 x Clip stops
- 1 x Guide (12mm kit)
- 2 x Guides (8 and 10mm kits)

# HUSKY GLASS SYSTEM

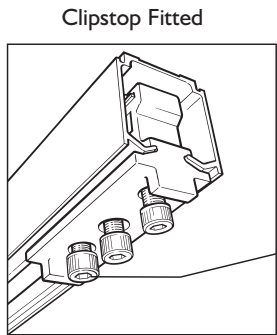
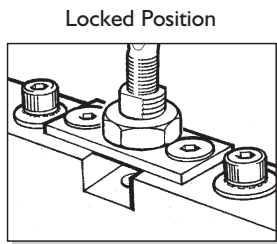

Soft  
 ↑  
 Clip Tension Adjustment  
 ↓  
 Firm

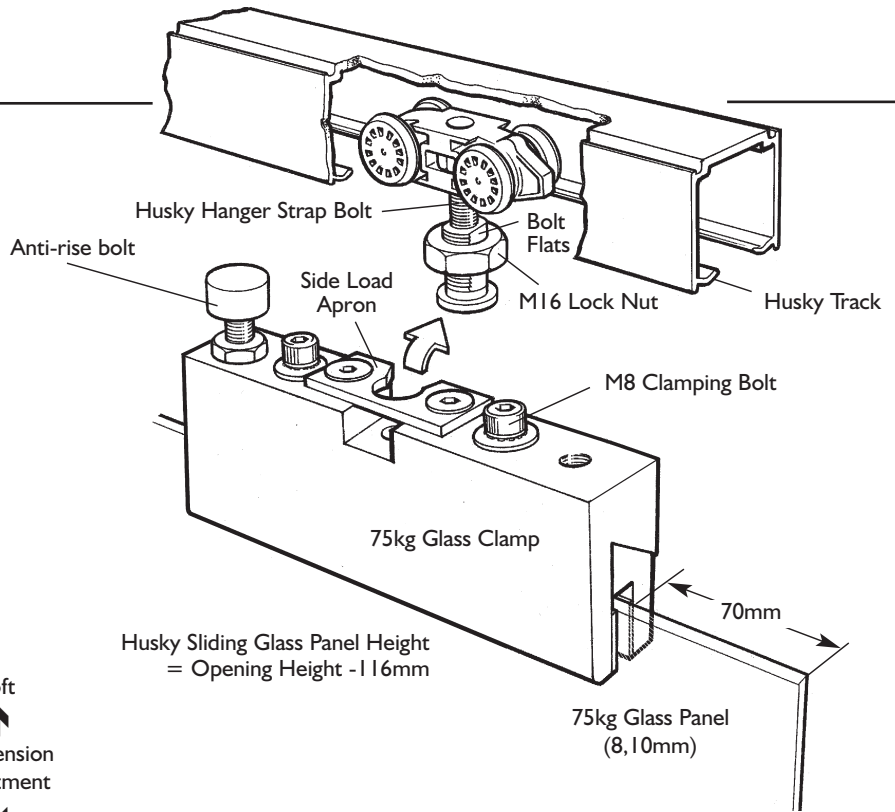

# PACER GLASS SYSTEM

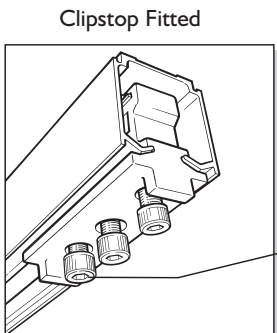
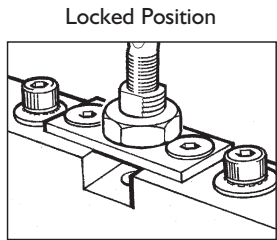

Soft  
 ↑  
 Clip Tension Adjustment  
 ↓  
 Firm

